

Measurement Guide

for Andersen® 400 Series Perma-Shield® Narroline® Double-Hung Window Conversion Kit

Thank you for choosing Andersen.

For questions call 1-888-888-7020 Monday - Friday, 7 a.m. to 7 p.m. and Saturday, 8 a.m. to 4 p.m. central time. For more information and/or guides visit andersenwindows.com.

- ▶ Read this measurement guide from beginning to end before starting. Read all warnings and cautions during unit installation.
- ▶ Read and follow product installation guide for installation instructions.

IMPORTANT

Andersen® Perma-Shield® Narroline® Double-Hung Window

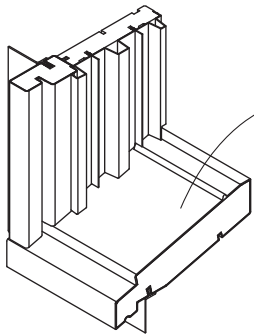

Wood Sill Core Covered with a Pre-formed Rigid Vinyl PVC Cladding

Narroline® conversion kits can only be used on Andersen® Perma-Shield® Narroline double-hung windows. They cannot be used on Narroline primed wood windows. For Narroline primed wood and other double-hung windows, please see Woodwright® double-hung insert window as an upgrade option.

1

Interior

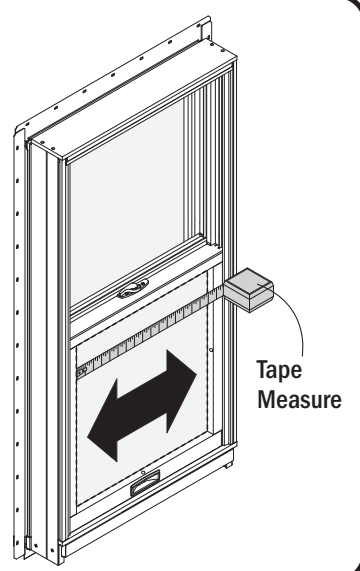

Measure unobstructed glass width (**bottom sash only**). Record width in inches on measurement worksheet.

2

Interior

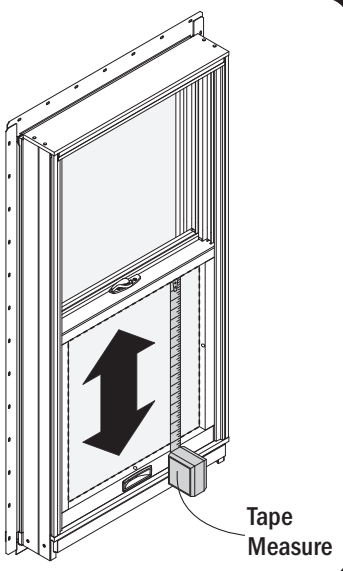

Measure unobstructed glass height (**bottom sash only**). Record height in inches on measurement worksheet.

Before Measuring:

- ▶ Open lower sash and determine material of sill cladding. If sill cladding is not rigid vinyl PVC, conversion kit will not work.
- ▶ Be sure existing frame is sound and suitable for window upgrade.
- ▶ Existing frame must be plumb, level and square.

Measuring Information:

- ▶ Record measurements on "Measurement Worksheet".
- ▶ Describe window style, options, and accessories clearly and record on worksheet.
- ▶ Measure each window even if they appear the same size.

3

Interior

▶ See size table on back side of worksheet.

example:

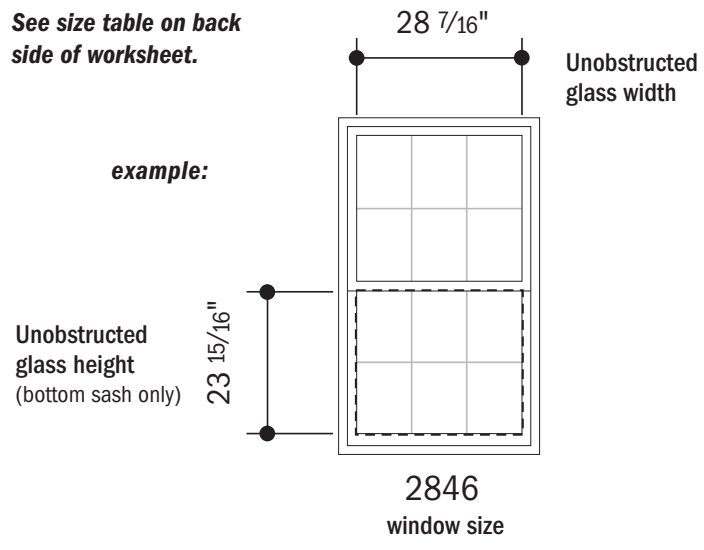

Determine existing window size from measured dimensions recorded in steps 1 and 2. (See size table on back side of worksheet).

for Andersen® 400 Series Perma-Shield® Narroline® Double-Hung Window Conversion Kit

Customer

























































NAME _____	PHONE _____
ADDRESS _____	E-MAIL _____
CITY/STATE/ZIP _____	ORDER DATE _____

Window Location	example: bathroom, _____		Window #	_____ of _____	
Window Size	bottom sash glass dimension		window size		Quantity needed of this window type: _____
	STEP 1 measured glass width _____ (width)	STEP 2 measured glass height _____ (height)	STEP 3 (See size table on back side of worksheet to determine window size) _____ (window size)		
Window Style & Color	sash style		sash color		
	 <input type="radio"/> equal sash	 <input type="radio"/> cottage style	exterior		interior
Glass Options	<input type="radio"/> non-tempered	<input type="radio"/> Low-E4 ⁺ glass	pattern	<input type="radio"/> white	<input type="radio"/> pre-finished white
	<input type="radio"/> tempered	<input type="radio"/> Low-E4 ⁺ SmartSun™ glass		<input type="radio"/> sandtone	<input type="radio"/> pine
Grille Style & Size	<input type="radio"/> with spacer	<input type="radio"/> no spacer	<input type="radio"/> no spacer, removable interior	<input type="radio"/> obscure	<input type="radio"/> cascade
	<input type="radio"/> removable interior only			<input type="radio"/> reed	<input type="radio"/> fern
Grille Pattern	<input type="radio"/> no grille			<input type="radio"/> laminate	
	 <input type="radio"/>	 <input type="radio"/>	 <input type="radio"/>	 <input type="radio"/>	<input type="radio"/> 3/4"
Insect Screens	<input type="radio"/> TruScene®		<input type="radio"/> half	<input type="radio"/> full	<input type="radio"/> white
	<input type="radio"/> conventional				<input type="radio"/> sandtone
Hardware	lock & keeper				
	<input type="radio"/> Estate™ <input type="radio"/> 1 <input type="radio"/> 2	double-hung sash lift(s) (optional)			
Hardware	<input type="radio"/> Classic Series™ (stone color for wood interiors or white color for white interiors) <input type="radio"/> 1 <input type="radio"/> 2	Estate™		traditional	
		<input type="radio"/> bright brass	<input type="radio"/> antique brass	<input type="radio"/> polished chrome	<input type="radio"/> brushed chrome
		<input type="radio"/> hand lift	<input type="radio"/> finger lift (pair)	<input type="radio"/> oil rubbed bronze	<input type="radio"/> distressed nickel
		<input type="radio"/> oil rubbed bronze	<input type="radio"/> distressed nickel	<input type="radio"/> distressed bronze	<input type="radio"/> stone
				<input type="radio"/> white	<input type="radio"/> stone

Notes and sketches

(sketch grille pattern)

Table of Basic Unit Sizes Scale 1/8" = 1'-0" (1:96)

Unobstructed Glass	16 7/16"	20 7/16"	24 7/16"	28 7/16"	32 7/16"	36 7/16"	40 7/16"
13 15/16"	 18210	 20210	 24210	 28210	 30210	 34210	 38210
15 15/16"	 1832	 2032	 2432	 2832	 3032	 3432	 3832
19 15/16"	 18310	 20310	 24310	 28310	 30310	 34310	 38310
21 15/16"	 1842	 2042	 2442	 2842	 3042	 3442	 3842
23 15/16"	 1846	 2046	 2446	 2846	 3046	 3446	 3846
27 15/16"	 1852	 2052	 2452	 2852	 3052	 3452	 3852
35 15/16"	 1856	 2056	 2456	 2856	 3056	 3456	 3856
33 15/16"	 1862	 2062	 2462	 2862	 3062	 3462	 3862